



Model: **RespiAid**

CPAP | AutoCPAP  
BPAP-30T | BPAP-30T Pro

**EN** **Instruction Manual**

[www.plusmed-health.com](http://www.plusmed-health.com)

## Declaration

Hebei Topson Medical Technology Co., Ltd, (hereinafter, the Company) owns the Copyrights of this non-public published manual, and reserves the rights to keep it as a confidential document. This user manual is just used as a reference for operation, maintenance and repair. The other people have no rights to disclose the information of the user manual to others.

This user manual contains the proprietary information protected by the copyright law. All rights reserved, please do not take photos or copy or translate into any other language in any part of this manual without the written consent of the company.

Everything written within this manual is considered to be correct. The company is not legally responsible for any mistakes printed within and/or any damages caused by incorrect installation and operation of the device. The company does not supply privileges endowed by the patent law to any other parties. The company is not legally responsible for the results caused by patent law breaking or any rights of the third party violating.

The users must read this user manual carefully before use the company's products. You can learn the operation steps which should be noted during the operation, the behaviors which may lead to abnormal operation or cause harm to the device or person. If the users do not operate the device according to the user manual, leading to any danger or harm to the person or device, the company does not undertake the guarantee responsibility about the security, reliability and performance about this and will not maintain the malfunction freely.

The company has the right to revise any content in this user manual without notice.

## **The manufacturer's liability**

The company has certain responsibilities for the safety, reliability and the function of the device when the users comply with the following operations strictly.

The adjustment and maintenance of the device should be completed by the service personnel who has been specially trained and appointed by the company.

The necessary electrical equipment and working environment must be consistent with the national standards, the industry standards and the user manual.

The device must be operated strictly according to the user manual.

## Notice for use

- a) Thank you for choosing our product.
- b) In order to use this device correctly and effectively, the users must read the user manual carefully before use.
- c) The users must understand fully and operate it comply with this user manual strictly when using this device.
- d) This product is only used for the purposes stated in this user manual.
- e) The repair and survey of this product can only be carried out by the trained professional maintenance personnel.
- f) Please do not hesitate to contact us if you have any problems during the operation, we would provide you with warm service.
- g) The specifications may be changed without prior notice.

<b>1 Introduction .....</b>	<b>8</b>
1.1 Warnings, Cautions .....	8
1.1.1 Warnings.....	8
1.1.2 Cautions.....	10
<b>2 Indications for use and Contraindications .....</b>	<b>12</b>
2.1 Indications for use .....	12
2.2 Contraindications .....	12
2.3 Working principle .....	13
2.4 Product components .....	14
<b>3 Product Introduction.....</b>	<b>15</b>
3.1 Unpacking checklist.....	15
3.2 Product diagram.....	16
3.2.1 Main device .....	16
3.2.2 Humidifier .....	18
3.3 Introduction about Buttons and Symbols .....	19
3.3.1 Buttons .....	19
3.3.2 Symbols.....	19
3.4 Description of different models .....	20
<b>4 Description for device interface and operation.....</b>	<b>21</b>
4.1 Standby interface .....	21
4.2 Treatment interface.....	22
4.3 User setting interface .....	23
4.4 Treatment information interface.....	27
<b>5 Use the device .....</b>	<b>29</b>
5.1 The first time use of the device.....	29
5.1.1 Connecting the humidifier .....	29

5.1.2 Adding water into the water tank.....	30
5.1.3 Installing the filter.....	32
5.1.4 Inserting the SD Card.....	33
5.1.5 Connecting the tube and the mask .....	34
5.1.6 Connecting the power line .....	35
5.1.7 Parameter Settings .....	35
5.1.8 Wear a mask and start treatment.....	35
5.2 Daily use.....	36
5.2.1 Adding water .....	36
5.2.2 Connecting the power supply, the tube and the mask.....	36
5.2.3 Switching on the device, Starting Treatment.....	36
5.2.4 Turning off the device, stopping treatment.....	37
5.2.5 Putting away the device.....	37
<b>6 Cleaning and maintenance .....</b>	<b>38</b>
6.1 Daily Cleaning.....	38
6.1.1 Cleaning the Mask and the head band.....	38
6.1.2 Cleaning the water tank.....	38
6.1.3 Replacing the filter.....	40
6.1.4 Cleaning the Shell .....	40
6.1.5 Cleaning the tube .....	41
6.2 Disinfection .....	41
<b>7 Expiry date for use.....</b>	<b>42</b>
<b>8 Malfunction and maintenance.....</b>	<b>42</b>
8.1 Common Problems and Corresponding Solutions .....	42
8.2 Detailed rules for the maintenance .....	44
<b>9 Disclaimer .....</b>	<b>45</b>
<b>10 Waste Disposal .....</b>	<b>45</b>

<b>11 Quality assurance .....</b>	<b>46</b>
<b>12 Technical Support.....</b>	<b>47</b>
<b>13 Technical indicators.....</b>	<b>47</b>
<b>Appendix 1 Setting and description of the ventilation parameters setting menu .....</b>	<b>51</b>
<b>Appendix 2 Setting and description of the maintenance parameter menu .....</b>	<b>54</b>
<b>Appendix 3 Manufacturer's declaration of EMC .....</b>	<b>55</b>

# 1 Introduction

Please read all of the information in this user manual thoroughly before use the Positive Airway Pressure Devices (hereinafter, the device). Be sure to use the device according to the doctor's prescription.

## 1.1 Warnings and Cautions

 Warnings: It may cause harm to the user or operator if there is any violation.

 Cautions: It may cause damage or malfunction to the device or affect the effectiveness of the device if there is any violation.

### 1.1.1 Warnings

 Warnings:

- a) This device is intended for adult use only, and it is not suit for Children.
- b) This device is not intended for life support.
- c) The use guide of this manual can not substitute for the health care.
- d) The device must be used with the doctor's guidance.
- e) The device can not be used when the room temperature is higher than 35°C, that is because if the room temperature is higher than 35°C, the airflow generated by the device may exceed 43°C, it may stimulate the human airway. So the room temperature must be kept below 35°C when use it.
- f) In order to reduce the possibility of carbon dioxide (CO<sub>2</sub>) rebreathing, the users should pay attention to the followings:
  - Please use the recommended tube and mask which is suitable



for the device provided by the Company.

- Please do not wear the mask for a long time when the device stops working.
  - You must use the mask with an exhaust hole, do not block or try to block the outlet connections on the mask.
- g) It may cause asphyxia if the patient did not use the mask or accessories which can reduce carbon dioxide rebreathing or allow spontaneous breathing.
- h) Please disconnect the power supply to prevent the electric shock before cleaning.
- i) Please pay attention to check whether the power line is damaged or not when connect it, replace it immediately if it is damaged.
- j) The device does not need sterilization.
- k) The shell must be dry completely when connect with the power after cleaning, to avoid the moisture affect the performance of the mainboard.
- l) Please stop using it immediately and contact the equipment supplier if the device has been dropped or mishandled, or the shell has been damaged or flooded.
- m) The device can not be used during MRI or CT examination.
- n) In order to avoid the risk of fire and burn, the device should be kept away from the oxygen source more than 1 meter.
- o) In order to ensure the delivery of the treatment pressure and minimize the rebreathing of CO<sub>2</sub>, the device should be used with the humidifier (Optional), tube (Included) which is supplied by the company. The mask must have got the CE Certification and confirmed by the company or the authorized agency.
- p) Oxygen can access the mask, the patient should pay attention to the followings when use the oxygen:
- Connect the oxygen tube with the oxygen junction of the mask.

- The oxygen which be used must meet the local medical oxygen standards.
- Turn on the device firstly and then turn on the oxygen valve when use the oxygen.
- In order to prevent the accumulation of oxygen in the device, turn off the oxygen valve firstly and then turn off the device.
- Oxygen is flammable, keep the device and oxygen source away from heat source, open fire, any oil or other flammable materials. Do not smoke near the device and the oxygen source.
- It is forbidden to connect the device to an uncalibrated or high-pressure oxygen source. It could affect the therapeutic effect seriously when the pressure of the oxygen source is higher than the device.
- Please do not use any ancillary equipment without the consent of the company or your doctor.

### 1.1.2 Cautions

#### **Cautions:**

- a) Keep the device far away from the heating or cooling equipment (e.g., ventilation fan, radiator, or air conditioner).
- b) Check the device regularly, do not use the defective one. Please replace the parts which are damaged, missing, visibly worn, deformed or contaminated immediately.
- c) The device is not suitable for working in a high humidity environment, make sure that there has no liquid penetrates into the device.
- d) Do not use any liquid to soak the device. Please disconnect the

power supply and scrub the surface of the device with clean water, and then the power can be switched on after drying.

- e) In order to avoid the electric shock risk, please cut off the power supply in the process of maintenance.
- f) Don't let the bed sheet, curtain or other items obstruct the air inlet, in order to avoid the blocking of the air passage.
- g) This device is not suitable for working in the environments of air (or Oxygen) mixed with flammable anesthetic, such as nitric oxide. To avoid explosion, do not use this product in an environment with flammable gases (such as narcotics).
- h) If the device was stored in very cold or very hot environment, keep it in the room for 2 hours before use. Make its temperature consistent with the room temperature during use.
- i) Storage Conditions:  $-20^{\circ}\text{C} \sim 60^{\circ}\text{C}$ , Relative humidity:  $10\% \sim 93\%$  Non-condensing.
- j) Working environment:  $5^{\circ}\text{C} \sim 35^{\circ}\text{C}$ , Relative humidity:  $10\% \sim 93\%$  Non-condensing.
- k) Do not connect with other objects except for the specified parts of the system.
- l) The tobacco smoke would be accumulated in the device, and that would lead to abnormal work.
- m) Check whether the tube is damaged or contains a foreign item before use.
- n) Pour out the water from the humidifier tank completely during the transportation and storage.

## **2 Indications for use and Contraindications**

### **2.1 Indications for use**

Positive Airway Pressure Devices is designed for the treatment of adult snore symptom, obstructive Sleep Apnea (OSA) only for patients weighing more than 30 kg. It is used at home or in hospital.

This device is only allowed to be used by the user whom was guided by the professional physician, and the device should be set before use. The professional physician should ensure that the users understand the various functions and the operation methods of this device.

### **2.2 Contraindications**

The user, whom should conform to the following conditions, should inform your doctor before use the device. It can be used only after the medical examination, and the doctor should make a diagnosis, it should be used under the special care and timely monitoring of the doctors.

**Absolute Contraindications:** Pneumothorax, mediastinal emphysema; cerebrospinal fluid leak, traumatic brain injury, or pneumocephalus; shock caused by a variety of conditions before treatment; active epistaxis; upper gastrointestinal bleeding before treatment; coma or impaired consciousness making the use of mask during therapy impossible; giant vocal fold polyp, etc.

**Relative Contraindications:** Severe coronary heart disease complicated with left ventricular failure, acute otitis media, excessive respiratory secretions and weak cough, weak spontaneous breathing, nasal or oral tracheal intubation and tracheotomy, severe nasal congestion caused by

a variety of conditions, lung bullae, and allergies to breathing masks, etc.

The following side effects may arise during the course of therapy with the device:

- Dry mouth, nose and throat
- Abdominal bloating
- Ear or sinus discomfort
- Eye irritation
- Skin irritation due to the use of a mask
- Chest discomfort

Caution: An irregular sleep schedule, alcohol consumption, obesity, sleeping pills, or sedatives may aggravate your symptoms.

## 2.3 Working principle

The device is composed of the motor, the control circuit, the sensor, the airflow output catheter and the mask. According to the preset, the machine would generate a certain level positive pressure and air flow, bring it to the upper respiratory tract of the patients through the tube and mask. Keep the patients' upper airway open and unobstructed through the positive pressure air flow to eliminate snoring, hypopnea and sleep apnea.

These devices include single-level continuous positive airway pressure devices and bi-level positive airway pressure devices (BPAP). There are two kinds of single-level continuous positive airway pressure devices, CPAP and Auto CPAP (APAP short for).

The CPAP works under the condition of adequate spontaneous Breathing. A preset continuous positive pressure airflow is applied

to the upper airway during the whole respiratory cycle according to the preset pressure value.

APAP is an automatic CPAP, it adjusts the pressure of the output airflow within the setting range automatically according to the feedback from whether the patient has snoring, flow limitation, hypopnea and sleep apnea or not.

BPAP provides different pressure values when the patients exhale and inhale. The inspiration pressure (IPAP) and expiration pressure (EPAP) can be presetted and adjusted within the setting range automatically.









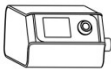

## **2.4 Product components**



The device is composed of main device, humidifier and accessories.

## 3 Product Introduction

### 3.1 Unpacking checklist

Please check the following parts when you open the box.

No.	Name	Picture	Quantity	Explanations
1	Main device		1	Included
2	Humidifier		1	Optional
3	Power cord		1	Included
4	Power adapter		1	Included
5	Filter		1	Included
6	SD card		1	Included
7	Tube		1	Included
8	Mask		1	Optional
9	User manual		1	Included
10	Carrying case		1	Optional

11	Quick guide		1	Included
12	Certification		1	Included

 **Warning:** This device should only be used with the mask and accessories recommended by Topson Medical or with those which are recommended by your prescribing physician. The use of inappropriate masks and accessories may affect the performance of the device and the treatment effect.

## 3.2 Product diagram

### 3.2.1 Main device

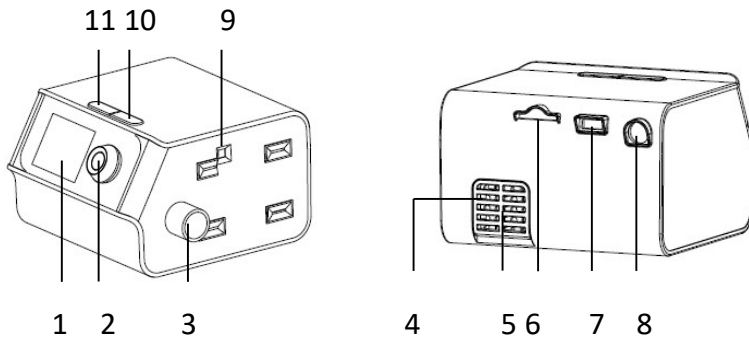



Components explanations

No.	Name	Explanation
1	LCD screen	Display the operation menus, Prompts and monitoring data.
2	Knob	Menu adjustment, selection, Confirmation key.
3	Main device outlet	A tube connector when using the main device alone
4	Main device inlet	The air can enter into the main device through it
5	Filter cap	There is a filter in the filter cap, in order to filter the dust from the air
6	SD card socket	The SD card is inserted into the main device
7	Communication port	Communication interface for the external devices
8	Power socket	DC power interface for the Power adapter output
9	Humidifier connector	Electrical connection for the main device and the humidifier.
10	Ramp button	Press this button to restart the ramp function when the device is working.
11	Start/Stop button	Starts or stops the machine.

### 3.2.2 Humidifier

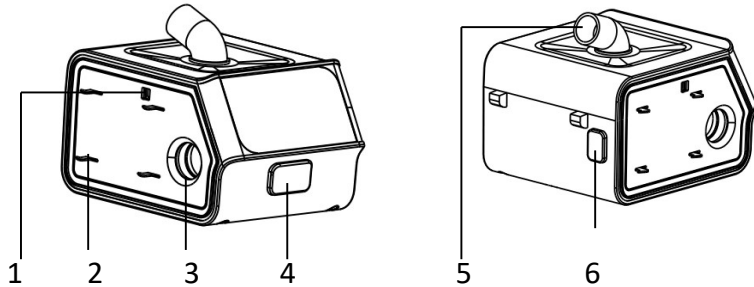



Components explanations









No.	Name	Explanation
1	Humidifier connector	connect with the electric of the main device
2	Humidifier hook	Connect with the main device
3	Humidifier inlet	the positive airway pressure provided by the main device enter into the humidifier through it
4	Water tank “unlock” button	Press this button to open the upper cover, take out the water tank or add water into the tank.
5	Humidifier air outlet	The connector about the humidifier and the tube.
6	The humidifier “unlock” button	Press this button to disconnect the humidifier and main device

### 3.3 Introduction about Buttons and Symbols

#### 3.3.1 Buttons

	Start/stop	In standby state, press this button, the device begins to work. In working state, press this button, the device stops working.
	Ramp button	In working state, press this button, the device begins to re-delay the pressure.

#### 3.3.2 Symbols

No.	Symbols	Explanation
1		SD Card
2	<b>SN</b>	Serial Number
3		Warning, Consult instructions for use
4		Type BF Applied part
5		Class II equipment
6	<b>IP22</b>	Enclosure protection class
7		WEEE Recycling
8		Please refer to the user manual
9		Alternating current power supply
10		Direct-current power supply
11		Max water level line

### 3.4 Description of different models

<b>Models</b>	<b>Working mode</b>	<b>Pressure adjusting range</b>	<b>Adjusting the ventilation parameters in real time.</b>
RespiAid CPAP	CPAP	4-20hPa	Nonsupport
RespiAid AutoCPAP	CPAP, APAP	4-20hPa	Nonsupport
RespiAid BPAP-30T	CPAP, APAP, BPAP-S, BPAP-T	4-30hPa	Support
RespiAid BPAP-30T Pro	CPAP, APAP, BPAP-S, BPAP-T, BPAP-ST	4-30hPa	Support

## 4 Description for device interface and operation

### 4.1 Standby interface

a) Interface introduction

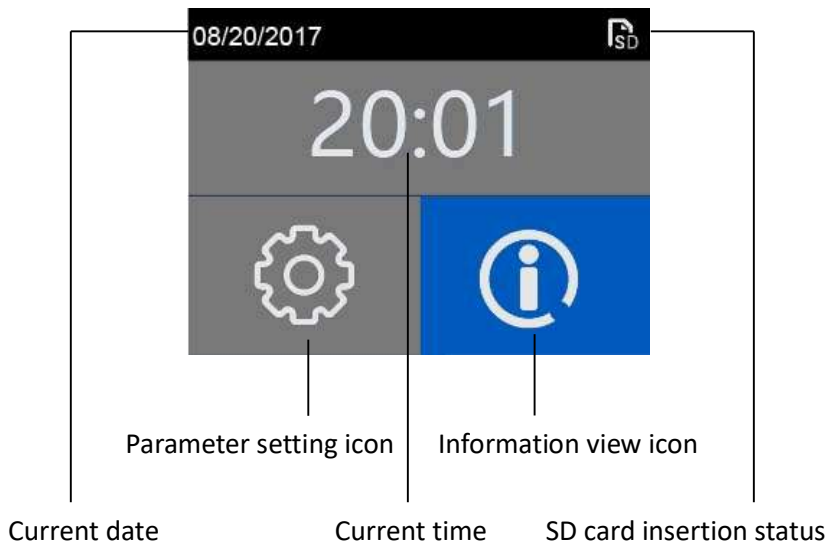

b) Operation: Switch on the device's power supply, the device enters into standby interface, as shown above.

## 4.2 Treatment interface

a) Interface introduction

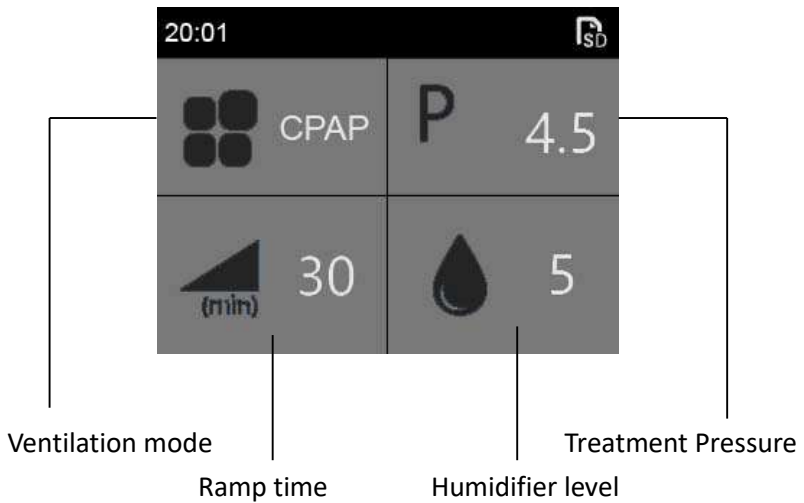

b) Operation: In the standby interface, press the start/stop button, the display shows treatment interface and start to work.

## 4.3 User setting interface

### a) Interface introduction

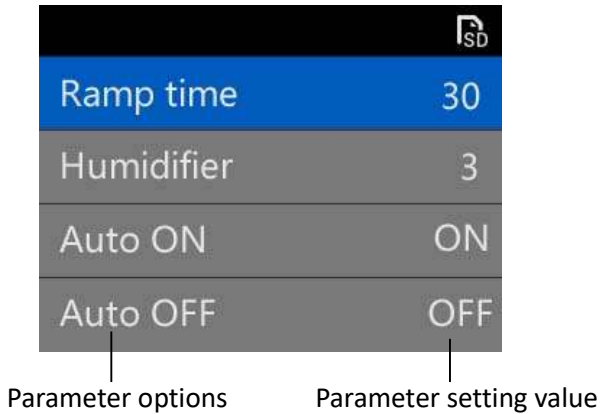

- b) Operation: Rotate the knob to select the user settings icon in the standby interface, the color of the icon would be changed into blue. Press the knob to enter the user interface. The steps to adjust the parameters are as follows:
- Rotate the knob to select the parameter options which should be modified, the selected parameter options would be changed into blue.
  - Press the knob to confirm the parameter options need to be modified, and the color of the parameter setting value becomes black.
  - Rotate the knob to adjust the parameter values which need to be modified.
  - Press the knob to complete the parameter modification. After all parameters are set, select the return option, press the button,

and return to the standby interface.

c) User setting parameters introduction

Parameter	Subparameter	Description
<b>Ramp time</b>	None	In order to make the user feel comfortable and easy to fall asleep, the output pressure will increase from the initial pressure to the treatment pressure gradually after the device start to work. The rise time can be set, the setting range is 0-60 minutes, the increment is 5 minutes, and the factory default is 30 minutes.
<b>Humidifier</b>	None	The humidifier level is set as OFF and level 1-5 to adapt to different environments and make the user feel comfortable. The users can set it according to the environments. The factory default is level 3. In addition, the users can also rotate the knob to set the humidification level in the treatment interface.
<b>Auto On</b>	None	To make the user feel convenient, the device is equipped with Auto On function. The user should connect the tube with the mask well, and wear the mask in the standby interface. The device would start to work when the users breathe once. The device with the



		function for the user to select open or closed, the factory default is open.
<b>Auto Off</b>	None	To make the user feel convenient, the device is equipped with Auto Off function. By the end of treatment, take off the mask, the device would stop automatically, and return to the standby interface. The device with the function for the user to select open or closed, the factory defaults is closed.
<b>Language</b>	None	The interfaces with the languages of Chinese, English and Spanish.
<b>Time &amp; Date</b>	Time Format	The machine has two time formats for the users` selection, 12-hour time and 24-hour time. The factory default is 24-hour time.
	Date Format	The machine is equipped with three time formats, that is year/month/day, day/month/year, month/day/year. The factory default is day/month/year.
	Year	/
	Month	/
	Day	/
	Hour	/
	Minute	/
	Back	Return to the last menu when the setup is completed

<b>About device</b>	Model	Check the specific model of this device
	SN	Check the serial number
	Software	Check the software version number of this device.
	Back	Return to the last menu when the setup is completed
<b>Back</b>	None	Return to the standby interface when the setup is completed

## 4.4 Treatment information interface

### a) Interface Introduction



Period	Three months
Valid days(>4h)	65
Used hour	7.0h
AHI	2.5

Treatment information options

Information value

- b) Operation: In the standby interface, rotate the knob to select the treatment information icon, the icon color would be changed into blue, press the knob, enter into the treatment information interface.

c) Information option introduction

<b>Information</b>	<b>Description</b>
<b>Period</b>	The statistics cycle of the treatment information
<b>Valid days(&gt;4h)</b>	The days of the use time longer than 4h
<b>Used hours</b>	Average use time for daily
<b>AHI</b>	The times about the apnea and hypopnea per average hour
<b>P90</b>	A kind of statistical indicator of pressure
<b>Leak90</b>	A kind of statistical indicator of air leakage
<b>Back</b>	Return to standby interface

## 5 Use the device

 Please use the device according to the doctor's prescription strictly.

### 5.1 The first time use of the device

Please go to the normal hospital for pressure titration before the first use.

Place the machine in a safe and reliable place when using it.

#### 5.1.1 Connecting the humidifier

- a) Press the “unlock” button of the humidifier: Hold the humidifier with the right hand, press and hold the “unlock” button with the right index finger, as shown in the figure below.

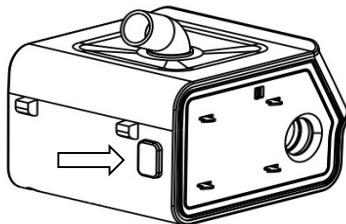

- b) Connect the humidifier: Hold the main device with the left hand, make the air outlet of the main device aligned with the air inlet of the humidifier. Connect the connector of the main device and the humidifier. Make sure the outlet of the main device insert into the inlet of the humidifier completely, and then loosen the “unlock” button of the humidifier, as shown in the figure below.

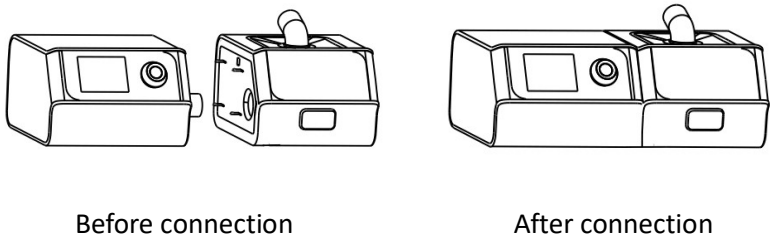

### 5.1.2 Adding water into the water tank

- a) Open the upper cover of the humidifier: Press the “unlock” button of the water tank, meanwhile, turn over the upper cover of the humidifier, as shown in the figure below.

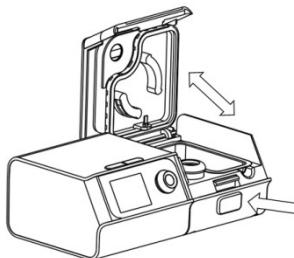

Figure 3-1

- b) Add water into the water tank: Take a cup of purified water, and fill it into the water tank to the max water level line, as shown in the figure below.

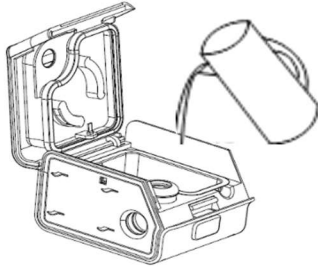

Figure 3-2

- c) Close the upper cover of the humidifier: Close it as shown in the figure below.

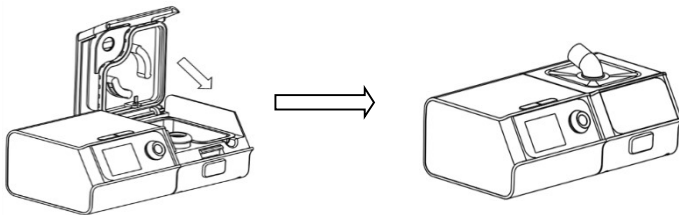
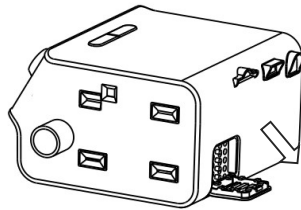

Figure 3-3

Figure 3-4

### 5.1.3 Installing the filter

- a) Open the filter cap: Open the filter cap follow the direction as shown below.



- b) Install the filter: Install the filter into the filter cap follow the direction as shown below. Please note that the filter should be hold by the button position of the filter cap.

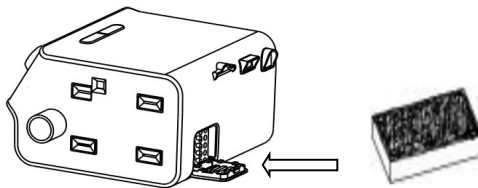



- c) Cover up the filter cap: Cover up the filter cap follow the direction as shown below.

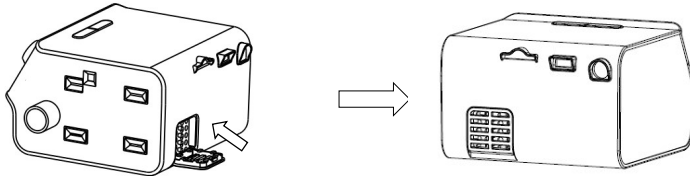

**⚠ Caution:** The inlet filter should be used with the one supplied by the company.

### 5.1.4 Inserting the SD Card

Insert the SD card follow the direction as shown below.

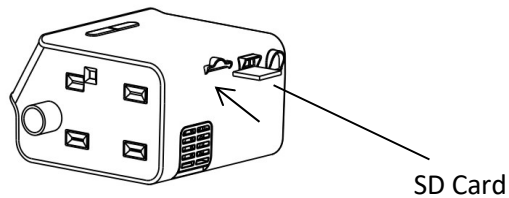

### 5.1.5 Connecting the tube and the mask

Connect the tube and the mask

Connect one end of the tube to the outlet of the main device, and connect the other end of the tube to the mask, as shown in the figure below.

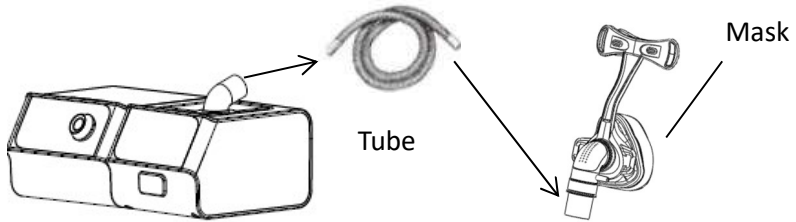

With the humidifier

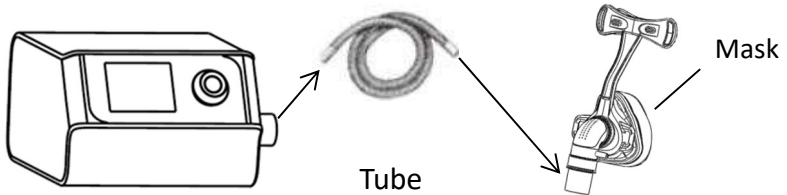

Without the humidifier

## 5.1.6 Connecting the power line

Connect the power line and switch on the power supply.

- a) Insert the plug of the power adapter into the DC power socket which behind the device.
- b) Connect the power line to the power adapter
- c) Finally, plug the power line into the power socket.

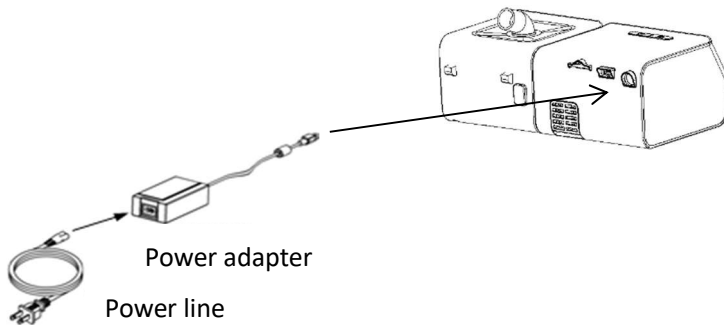

## 5.1.7 Parameter Settings

Please set your ideal parameters according to the method described in 4.3 in this manual.

## 5.1.8 Wear a mask and start treatment

- a) Wear well the mask according to the requirement of the mask operation instruction in the accessories.
- b) **Start treatment:** Press  start/stop button or use the automatic starting function, the device start to work, and then enter into the treatment status.

## **5.2 Daily use**

### **5.2.1 Adding water**

Open the upper cover of the humidifier to check the water level, discard the water in the water tank, and refill it with the purified water to the highest water level. Notice: Make sure to pour off the rest of the water which you used last time.

### **5.2.2 Connecting the power supply, the tube and the mask**

Connect the power supply, the tube and the mask well according to the method described in 5.1.

### **5.2.3 Switching on the device, Starting Treatment**

Start the device according to the method described in 5.1, please note that this device has memory function, it would remember the parameters that the user set up last time automatically. So the device would start the ventilation treatment according to the parameters used last time if the parameters are not been reset. Then, the parameters should not be reset if the users feel comfortable last time.

## **5.2.4 Turning off the device, stopping treatment**

When the users stop the treatment, press the start/stop button, the device would stop the ventilation treatment, or use the Auto off function, the users take off the mask, the machine will turn off automatically, and stop the ventilation treatment.

## **5.2.5 Putting away the device**

When the treatment is finished, pull up the plug from the network power supply, pull the DC power plug of the main device, separate the tube and mask. Put away the power line, the power adapter, the device, the tube and mask to avoid dust and mosquito enter into the device and the tube.

## **6 Cleaning and maintenance**

Regular cleaning of the device and its accessories is very important for the prevention of respiratory infections. The mask and the head band and the water tank is recommended to be cleaned by water once every day, and the device shell, tube and atomization components should be cleaned once a week. Please do not use cleaning agents, alcohol, chlorine-containing substances, acetone, or other solvent clean the device and the accessories.

### **6.1 Daily Cleaning**

#### **6.1.1 Cleaning the Mask and the headgear**

For specific cleaning steps, please refer to the cleaning part in the user manual for the mask.

#### **6.1.2 Cleaning the water tank**

- a) Take out the water tank: Press the “unlock” key of the humidifier, meanwhile, turn over the upper cover of the humidifier, and take out the water tank follow the direction shown below

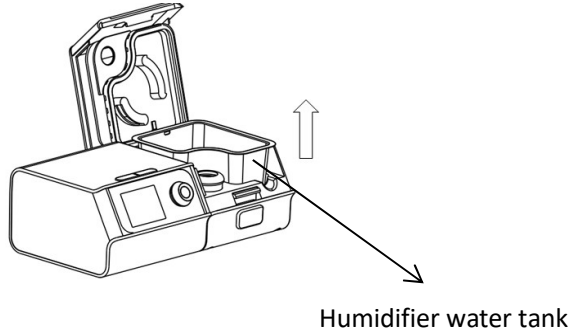

- b) Clean the water tank: Put the water tank into clean water (You may add washing liquid or vinegar when it is necessary), it should be soaked for about 15 minutes. Discard the water, dry it with a soft cleaning tool, repeat this for 2-3 times, then air-dry it in air. Note: There is a heating plate under the tank. Do not soak the heating plate. If it was stained with water carelessly, dry it with a dry cloth, and then air-dry it in the air.

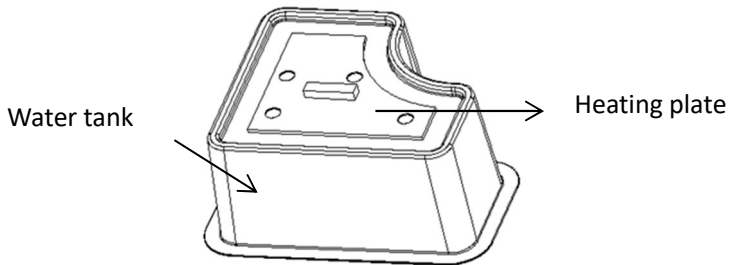

- c) Install the water tank: Put the water tank into the humidifier as shown in the figure below, and close the upper cover of the humidifier and lock it tightly.

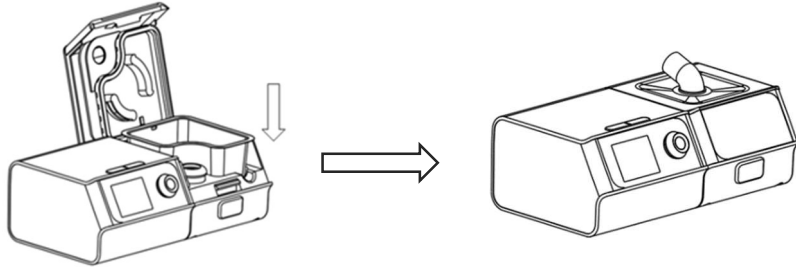

### 6.1.3 Replacing the filter

**⚠️Cautions:** Do not install the wet filter into the device. The filter should be replaced once every 6 months at least. (Depending on the local air quality, the replacement cycle can be shortened. If there is any damage or cracking, please replace it in time) the filter can only be replaced and cannot be cleaned.

Replace the new filter with the method described in 5.1.3 of this manual.

### 6.1.4 Cleaning the Shell

Wipe the surface of the device and the humidifier with a soft, slightly damp cloth. (Wash the cloth and then wring dry)



 Caution: In order to avoid the moisture enters into the device and then influence the performance of the mainboard, the power supply should be connected after the device shell is dry completely.

### **6.1.5 Cleaning the tube**

Remove the tube from the device and mask before cleaning, clean the tube with warm water which contains mild washing liquid, and then rinse it with clean water thoroughly. Put the clean tube in the well-ventilated area from direct-sun exposure for about 30 minutes. Check whether the tube is completely dry before re-use. Make sure there has no water remained.

## **6.2 Disinfection**

Generally, you do not need to disinfect the device if you have followed the above cleaning instructions strictly in the use period. Use the neutral disinfectant to sterilize the device when it was contaminated or after the clinical use.

### **Disinfection of the Humidifier Water Tank:**

Disinfect the humidifier water tank with the steps described in 6.1.2 of this manual. Clean the water tank with water which contains neutral disinfectants, and then rinse it with clean water thoroughly.

## 7 Expiry date for use

The period of validity about this device is 5 years since it is out of the factory.

## 8 Malfunction and maintenance

### 8.1 Common Problems and Corresponding Solutions

The table below listed out the common problems and solutions. Contact the equipment supplier maintenance service center or the doctor if none of the corrective actions can solve your problem.

<b>Problem</b>	<b>Possible Cause</b>	<b>Solution(s)</b>
Dry, blocked, cold of nose and throat	The gas is too dry, meanwhile, the temperature is too low	Improve the humidity Level or consult a doctor.
Dry mouth and throat	The gas does not play the humidification function when opening the mouth to breathe	Use a full face mask or consult a doctor.

<p>Water in mask or tube</p>	<p>The room temperature is too low, the user's exhaled air tends to condensation phenomenon.</p>	<p>Raise the room temperature or reduce the humidity level</p>
<p>The temperature of the inhaled air is too high</p>	<p>The air inlet of the device may be partially blocked The level of the humidifier is too high. There is no water in the water tank of the humidifier.</p>	<p>Replace the filter, check the air inlet, and place the device at a distance of 20cm from the curtain or wall. Reduce the humidity level. Add purified water into the water tank.</p>
<p>There has no airflow output when press the start button</p>	<p>The power plug is not connected. Fuse malfunction Fan connection malfunction</p>	<p>Check for the power supply. Contact the after-sales staff to maintain and replace the fuse, etc.</p>
<p>The device is too noisy</p>	<p>The tube is not connected properly. The tube is leaky</p>	<p>Check whether the tube is connected properly. Check whether the tube is leaky.</p>

<p>The LCD screen is Bright but there has no output pressure</p>	<p>1.Fuse malfunction of the fan 2.Circuit board malfunction 3.The pressure of the device should be calibrated.</p>	<p>Contact the after-sales staff to check and maintain or replace the device and perform corresponding pressure calibration.</p>
--	---	--

## 8.2 Detailed rules for the maintenance

Please note the following maintenance details.:

- a) It is the responsibility of the users to maintain and service the device.
- b) Please contact the equipment supplier to maintain the device when the device runs abnormally or broken-down. Only the authorized personnel can repair this device.
- c) The users shall bear all the responsibilities if the device was operated or repaired by the personnel without the company training, resulting in malfunction.
- d) Do not open the shell of the device, please contact the equipment supplier immediately if the device was damaged or broken-down.
- e) Besides the regular cleaning and maintenance, it is likely that the pressure is not stable if the users feel uncomfortable because of the output pressure reduces or increases, please contact the equipment supplier for testing and servicing.

## 9 Disclaimer

The company will not be responsible for any of the following damages.

- a) It is not our company's professional personnel to assemble, upgrade, adjust or repair.
- b) The device was not operated according to the operation specification.
- c) The user did use the accessories which provided or recommended by the company.
- d) Making any technical adjustment without the consent of the company.

## 10 Waste Disposal

When the device reaches the end of its service life, dispose the device and packaging in accordance with local laws and regulations. Generally, the device, the cardboard for packing and the protective plastics should be sent to the reclaiming organizations. The reclaiming organizations should be able to dispose of plastics, metal parts, printed circuit boards, cable wires, humidifier heating plates and motor materials, etc.

## 11 Quality assurance

Each of the device and accessories are complete, the functions are normal and meet all of the specifications in the user manual.

If there is something wrong with the performance within 7 days from the date of purchase, you may choose to return, replace or repair it.

The device is not allowed to be dismantled without the company's permission, otherwise, it is deemed that the user has given up the maintenance.

The castoff or device shall be disposed in accordance with relevant local laws and regulations or sent back to the company.

Under normal operation, the warranty period for our device and accessories is as follows:

<b>Product and the accessories</b>	<b>Warranty period</b>
The device (Humidifier included)	2 Years
Power adapter	1 Year
SD Card	1 Year
Mask	90 Days
Tube	90 Days
Water tank	90 Days

Note: The Company has the right of final explanation about the warranty period of this product.

## 12 Technical Support

Please contact the company directly if you need the circuit diagram, components list due to special needs, such as maintenance or connecting to other devices. We would provide some or all of the circuit diagram and the technical data according to your requirements.

## 13 Technical specifications

Device Size	140 mm × 156mm × 94 mm (without Humidifier) 262 mm × 156mm × 94mm (with Humidifier)	
Environment conditions	Normal operation	Transport and storage
	Temperature: 5°C ~ 35°C	-20°C ~ +60°C
	Humidity: 10% ~ 93%, Non-condensing	10% ~ 93%, Non-condensing
	Atmospheric Pressure : 760 ~ 1060 hPa	760 ~ 1060 hPa
Note: The pressure value is given by 100 pa [hPa], 1 centimeter water column [cmH <sub>2</sub> O] = 0.98 hPa.		
Production date	It can be acquired on the device label.	
Operating life	The device can be used for five years if the users operate, maintain, and clean it according to the user manual. The operating life can be extended if the critical components are replaced.	

Working mode	Continuous mode, the continuous work time is no less than 8 hours.
SD Card	The capacity is no less than 8G, it can record the users' treatment date.
Power supply requirement	Alternating voltage: 100 ~ 240 V; Frequency: 50 Hz / 60 Hz; Input power: ≤2 A
Security type	Class II 、 Type BF Applied Part
Waterproof level	IP22 –Drip proof equipment
Pressure range	4 ~ 25 hPa (±0.5 hPa)。
Pressure display accuracy	±0.5 hPa
Pressure adjustable range	See section 3.4
Operating mode	See section 3.4
Ramp time	The range of adjustment is 0 ~ 60 minutes
Noise	When the output pressure of the device is 10 hPa, its noise (A level of weighted sound pressure level) is not greater than 30 dB.
The user connector specification	φ22 mm cone joint
Filter specification	The most penetrating particle size is 10μm



The highest pressure about the patient connector	Single level normal state,20 hPa; Single fault state, not more than 30 hP Bi-Level normal state,25 hPa; Single fault state, not more than 40 hP					
Ventilatory capacity	The average flow rate of the user connection should be greater than the corresponding flow value in the following table when the working pressure is set as the values listed in the table below					
	Testing pressure (hPa)	4	9	15	20	25
	Average flow rate of the user connection (L/min)	80	90	90	70	70
Humidifier	a) Temperature range of the humidifier: Adjustable from 0 to 5. b) The gas temperature of the user connection should be $\leq 43^{\circ}\text{C}$ .					
Capacity for Humidifier water tank	$\geq 240\text{ml}$					
Tube	Length 1.8 m, Error: $\pm 0.18\text{ m}$ , $\varnothing 22\text{mm}$ .					
Weight	Without humidifier: $< 1\text{ kg}$ ; Humidifier included: $< 1.6\text{ kg}$					

Dynamic pressure stability	Pressure (hPa)	Respiratory rate 10BPM	Respiratory rate 15BPM	Respiratory rate 20BPM
	4	$\pm 0.5$	$\pm 0.55$	$\pm 0.60$
	9	$\pm 0.80$	$\pm 0.85$	$\pm 0.85$
	15	$\pm 0.95$	$\pm 0.95$	$\pm 0.95$
	20	$\pm 0.95$	$\pm 0.95$	$\pm 1.0$
	25	$\pm 1.0$	$\pm 1.0$	$\pm 1.0$
	Standard Tube			

## Appendix 1 Setting and description of the ventilation parameters setting menu

- a) This manual is only for the clinical use.
- b) Interface introduction



Mode	CPAP
Start pressure	4.0
Treat pressure	7.0
Pressure unit	hPa

Parameter options

Parameter setting value.

- c) Operation: Press the knob and the Ramp button at the same time for more than 3 seconds, and then enter into the ventilation parameter setting interface. The steps to adjust the parameters are as follows:
  - a. Rotate the knob to select the parameter options which need to be modified, when selected, the color of the icon would be changed into blue.
  - b. Press the knob to confirm the parameter option need to be modified, and color of the parameter setting value would become into black.

- c. Rotate the knob to adjust the parameter values which need to be modified.
  - d. Press the knob to complete the parameter modification. After all parameters are set, select the return option, press the button, and return to the standby interface.
- d) Introduction about the Ventilation treatment parameters

Parameter Name	CPAP	APAP	BPAP-S	BPAP-Auto S	Setting range	step length
Start pressure	√	√	√	√	4.0 hPa - 20.0 hPa	0.5hPa
Treat pressure	√				4.0- 20.0 hPa	0.5hPa
Max pressure		√			4.0- 20.0 hPa	0.5hPa
Min pressure		√			4.0- 20.0 hPa	0.5hPa
IPAP			√		4.0 hPa – Max Pressure	0.5hPa
Min IPAP				√	4.0 hPa - Max Pressure	0.5hPa
Max IPAP				√	4.0 hPa - Max Pressure	0.5hPa
EPAP			√	√	4.0 hPa - Max Pressure	0.5hPa

<b>I Sensitive</b>			<b>√</b>	<b>√</b>	High, medium, low	--
<b>E Sensitive</b>			<b>√</b>	<b>√</b>	High, medium, low	--
<b>Back RR</b>			<b>√</b>	<b>√</b>	On、 Off	--
<b>EP-Flex level</b>	<b>√</b>	<b>√</b>			OFF、 1、 2、 3	--
<b>EP-Flex times</b>	<b>√</b>	<b>√</b>			Ramp in the whole process	--
<b>Leak alert</b>	<b>√</b>	<b>√</b>	<b>√</b>	<b>√</b>	On、 Off	--

---Should ensure the compatibility of the equipment and all of the part and accessories used to connect to the patient before use;

---Should ensure that the therapeutic pressure setting were determined for patient individually with the configuration of the equipment to be used, including accessories;

---Should periodically reassess the setting(s) of the therapy for effectiveness.

## Appendix 2 Setting and description of the maintenance parameter menu

This menu is only for the company's authorized customer service engineer.

Maintenance item	Description
Run time	Show the total use time of the motor
Filter time	Show the use time of the filter
Filter period	Off, one month, three months, six months could be set, the default time is three months
Backlight	Automatically and normally on could be set.
Mask Test	Test the Curve about the mask leakage
Factory reset	The treatment parameters and treatment data would be restored to the factory value.

## **Appendix 3 Manufacturer's declaration of EMC**

The customer or the user of the Positive Airway Pressure should assure that it is used in such an environment specified by table 1, table 2, table 4 and table 6, otherwise, could result in the device improper operation.

**WARNING:** Use of Positive Airway Pressure adjacent to or stacked with other equipment should be avoided because it could result in improper operation. If such use is necessary, Positive Airway Pressure and the other equipment should be observed to verify that they are operating normally.

**WARNING:** Use of accessories, transducers and cables other than those specified or provided by the manufacturer of Positive Airway Pressure could result in increased electromagnetic emissions or decreased electromagnetic immunity of the device and result in improper operation.

**WARNING:** Portable RF communications equipment (including peripherals such as antenna cables and external antennas) should be used no closer than 30 cm (12 inches) to any part of the device, including cables specified by the manufacturer. Otherwise, degradation of the performance of this equipment could result.

**Table 1**

Guidance and MANUFACTURER'S declaration – ELECTROMAGNETIC EMISSIONS		
<p>Positive Airway Pressure is intended for use in the electromagnetic environment specified below.</p> <p>The customer or the user of the Positive Airway Pressure should assure that it is used in such an environment.</p>		
Emissions test	Compliance	Electromagnetic environment – guidance
RF emissions CISPR 11	Group 1	Positive Airway Pressure uses RF energy only for its internal function. Therefore, its RF emissions are very low and are not likely to cause any interference in nearby electronic equipment.
RF emissions CISPR 11	Class B	Positive Airway Pressure is suitable for use in all establishments other than domestic and those directly connected to the public low-voltage power supply network that supplies buildings used for domestic purposes.
Harmonic emissions IEC 61000-3-2	Class A	
Voltage fluctuations/ flicker emissions IEC 61000-3-3	Comply	



**Table 2**

Guidance and manufacturer's declaration – electromagnetic immunity			
<p>Positive Airway Pressure is intended for use in the electromagnetic environment specified below.</p> <p>The customer or the user of the device should assure that it is used in such an environment.</p>			
IMMUNITY test	IEC 60601 test level	Compliance level	Electromagnetic environment – guidance
<p>Electrostatic discharge (ESD) IEC 61000-4-2</p>	<p><math>\pm 8</math> kV contact <math>\pm 15</math> kV air</p>	<p><math>\pm 8</math> kV contact <math>\pm 15</math> kV air</p>	<p>Floors should be wood, concrete or ceramic tile. If floors are covered with synthetic material, the relative humidity should be at least 30 %.</p>
<p>Electrical fast transient/burst IEC 61000-4-4</p>	<p><math>\pm 2</math> kV for power supply lines <math>\pm 1</math> kV for input/output lines</p>	<p><math>\pm 2</math> kV for power supply lines not comply</p>	<p>Mains power quality should be that of a typical commercial or hospital environment.</p>

<p>Surge IEC 61000-4-5</p>	<p>± 1 kV line(s) to line(s) ± 2 kV line(s) to earth</p>	<p>± 1 kV line(s) to line(s) ± 2 kV line(s) to earth</p>	<p>Mains power quality should be that of a typical commercial or hospital environment.</p>
<p>Voltage dips, short interruption s and voltage variations on power supply input lines IEC 61000-4-11</p>	<p>&lt;5 % UT (&gt;95 % dip in UT) for 0,5 cycle  40 % UT (60 % dip in UT) for 5 cycles  70 % UT (30 % dip in UT) for 25 cycles  &lt;5 % UT (&gt;95 % dip in UT) for 5 s</p>	<p>&lt;5 % UT (&gt;95 % dip in UT) for 0,5 cycle  40 % UT (60 % dip in UT) for 5 cycles  70 % UT (30 % dip in UT) for 25 cycles  &lt;5 % UT (&gt;95 % dip in UT) for 5 s</p>	<p>Mains power quality should be that of a typical commercial or hospital environment. If the user of the device requires continued operation during power mains interruptions, it is recomm- ended that the device be powered from an uninterruptible power supply or a battery.</p>

<p>Power frequency (50/60 Hz) magnetic field IEC 61000-4-8</p>	<p>30A/m</p>	<p>30 A/m</p>	<p>Power frequency magnetic fields should be at levels characteristic of a typical location in a typical commercial or hospital environment.</p>
--	--------------	---------------	--

**Table 4**

Guidance and manufacturer’s declaration – electromagnetic immunity		
<p>Positive Airway Pressure is intended for use in the electromagnetic environment specified below.</p> <p>The customer or the user of the device should assure that it is used in such an environment.</p>		
IMMUNITY test	IEC 60601 test level	Compliance level
Conducted RF IEC 61000-4-6	3 Vrms	3 Vrms 6 Vrms
	6 Vrms	
	150 kHz to 80MHz	
	ISM bands between 150 kHz to 80 MHz	
	3 V/m, 80 MHz to 2700MHz;	
	27 V/m,385MHz;	
	28 V/m,400MHz;	
	9V/m,710MHz;	
	9V/m,745MHz;	
	9V/m,780MHz;	
Radiated RF IEC 61000-4-3	28V/m,810MHz;	3V/m 9V/m 27 V/m 28 V/m
	28V/m,870MHz;	
	28V/m,930MHz;	
	28V/m,1720MH;	
	28V/m,1845MH;	
	28V/m,1970MH;	
	28V/m,2450MH;	
	9V/m,5240MHz;	
	9V/m,5500MHz;	
	9V/m,5785MHz;	

**Electromagnetic environment – guidance**

Portable and mobile RF communications equipment should be used no closer to any part of the device, including cables, than the recommended separation distance calculated from the equation applicable to the frequency of the transmitter.

Recommended separation distance

$$d = \left[ \frac{3,5}{V_1} \right] \sqrt{P}$$

$$d = \left[ \frac{3,5}{E_1} \right] \sqrt{P} \quad 80\text{MHz to } 800\text{ MHz}$$

$$d = \left[ \frac{7}{E_1} \right] \sqrt{P} \quad 80\text{MHz to } 2,5\text{ GHz}$$

where P is the maximum output power rating of the transmitter in watts (W) according to the transmitter manufacturer and d is the recommended separation distance in metres (m).

Field strengths from fixed RF transmitters, as determined by an electromagnetic site survey, <sup>a</sup> should be less than the compliance level in each frequency range. <sup>b</sup>

Interference may occur in the vicinity of equipment marked with the following symbol:



NOTE: These guidelines may not apply in all situations. Electromagnetic propagation is affected by absorption and reflection from structures, objects and people.

- a. Field strengths from fixed transmitters, such as base stations for radio (cellular/cordless) telephones and land mobile radios, amateur radio, AM and FM radio broadcast and TV broadcast cannot be predicted theoretically with accuracy. To assess the electromagnetic environment due to fixed RF transmitters, an electromagnetic site survey should be considered. If the measured field strength in the location in which the [ME EQUIPMENT or ME SYSTEM] is used exceeds the applicable RF compliance level above, the device should be observed to verify normal operation. If abnormal performance is observed, additional measures may be necessary, such as re-orienting or relocating the device.
- b. Over the frequency range 150 kHz to 80 MHz, field strengths should be less than [V1] V/m.

**Table 6**

Recommended separation distances between portable and mobile RF communications equipment and the device

The device is intended for use in an electromagnetic environment in which radiated RF disturbances are controlled. The customer or the user of the device can help prevent electromagnetic interference by maintaining a minimum distance between portable and mobile RF communications equipment (transmitters) and the device as recommended below, according to the maximum output power of the communications equipment.

Rated maximum output power of transmitter W	Separation distance according to frequency of transmitter m		
	150 kHz~80 MHz $d = 1.2\sqrt{P}$	80 MHz~800 MHz $d = 1.2\sqrt{P}$	800 MHz~2.5 GHz $d = 2.3\sqrt{P}$
0,01	0.12	0.12	0.23
0,1	0.38	0.38	0.73
1	1.2	1.2	2.3
10	3.8	3.8	7.3
100	12	12	23

For transmitters rated at a maximum output power not listed above, the recommended separation distance  $d$  in meters (m) can be estimated using the equation applicable to the frequency of the transmitter, where  $P$  is the maximum output power rating of the transmitter in watts (W) according to the transmitter manufacturer.

NOTE 1 At 80 MHz and 800 MHz, the separation distance for the higher frequency range applies.

NOTE 2 These guidelines may not apply in all situations. Electromagnetic propagation is affected by absorption and reflection from structures, objects and people.

**İthalatçı/Distribütör: Trimpeks İth. İhr. Tur. ve Tic. A.Ş.**

Sultan Selim Mah. Yunus Emre Cad. No:1/11 Kağıthane  
34415 İSTANBUL, TÜRKİYE Tel +90 212 319 50 00



**CE**  
**0123**

Plusmed\_IB\_RespiAid\_verA\_00

Revision Date: 26/02/2021